



HERMANN RESIDENCE
217 West Shore Road
Washington, Connecticut 06777

Stoneleaf Construction LLC
4974 Route 22, Amenia, NY 12501
(212)-273-9712 (845) 373-8020

Submittal No: 131100-01.02

Submittal Title: Pool Construction & Equipment

Submittal Type: Shop Drawing & Product Data

COMMENTS:

- COPING STONE: Options in the trailer
- WATERLINE TILE: Please select 6"x6" or 6"x12" - <https://www.nptpool.com/tile/>
- PEBBLE SHEEN FINISH: Options in the trailer
- AUTO POOL COVER FABRIC FINISH: Options in the trailer
- WINTER POOL COVER FABRIC: Options in the trailer
- POOL EQUIPMENT LAYOUT: LCP needs 4'x12' pad for their pool equipment

STAMP

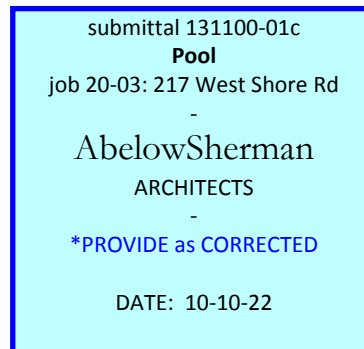



HERMANN PROJECT

20' x 50' Swimming Pool
10' x 10' Sunken Spa
3'6" to 7'0" Depth
16" wide x 2" thick Coping / 14" Pool Beam
6 Pool Lights / 1 Spa Light

Salt Water Chlorination
Automatic Controls
Automatic Pool Cover
Pebble Sheen Plaster

submittal 131100-01c
Pool
job 20-03: 217 West Shore Rd
-
Abelow Sherman
ARCHITECTS
-
***PROVIDE as CORRECTED**

DATE: 10-10-22



10' x 10' Spa Layout

submittal 131100-01c
Pool
job 20-03: 217 West Shore Rd
AbelowSherman
ARCHITECTS
*PROVIDE as CORRECTED
DATE: 10-10-22

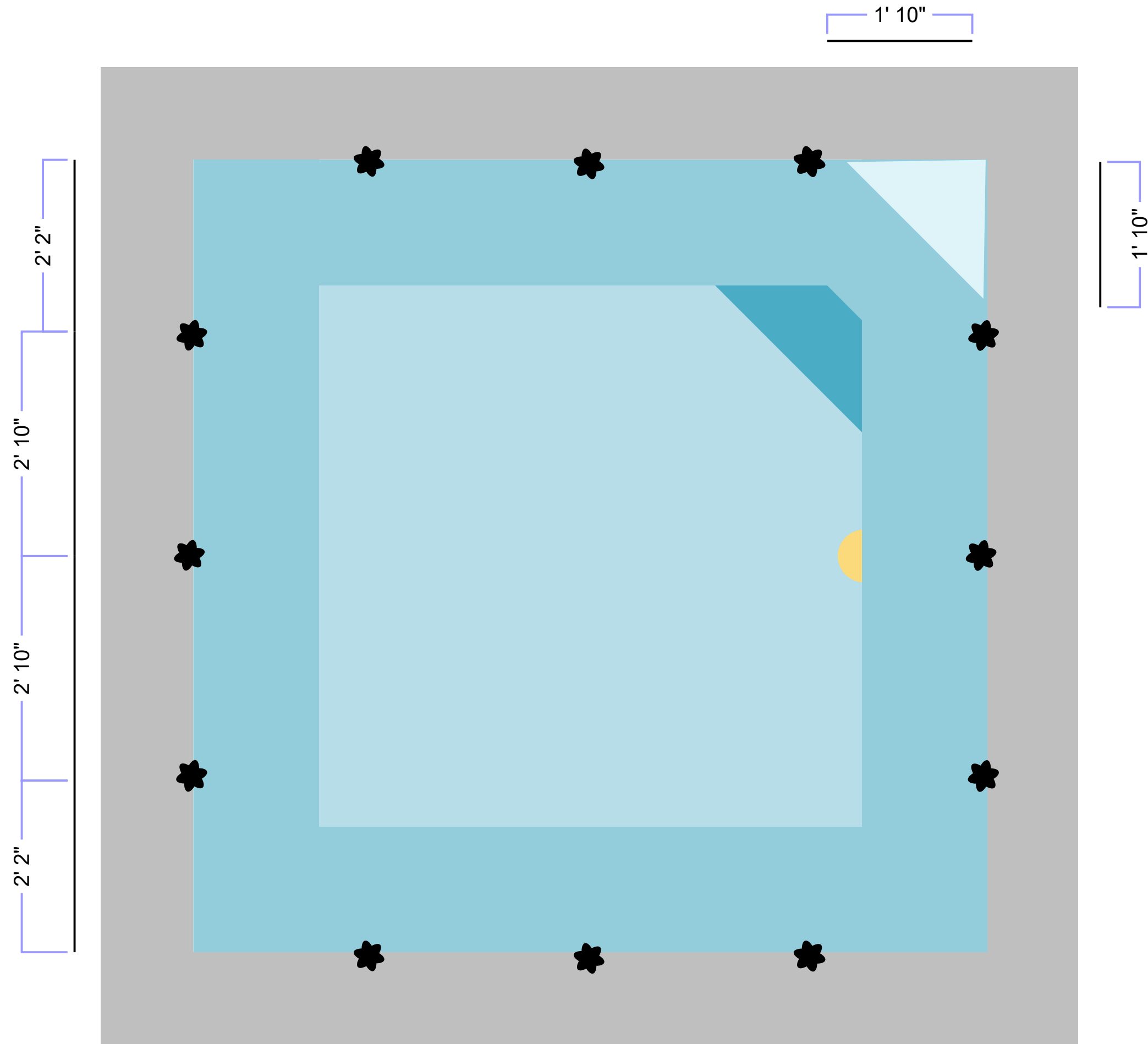

SPA DEPTH LAYOUT

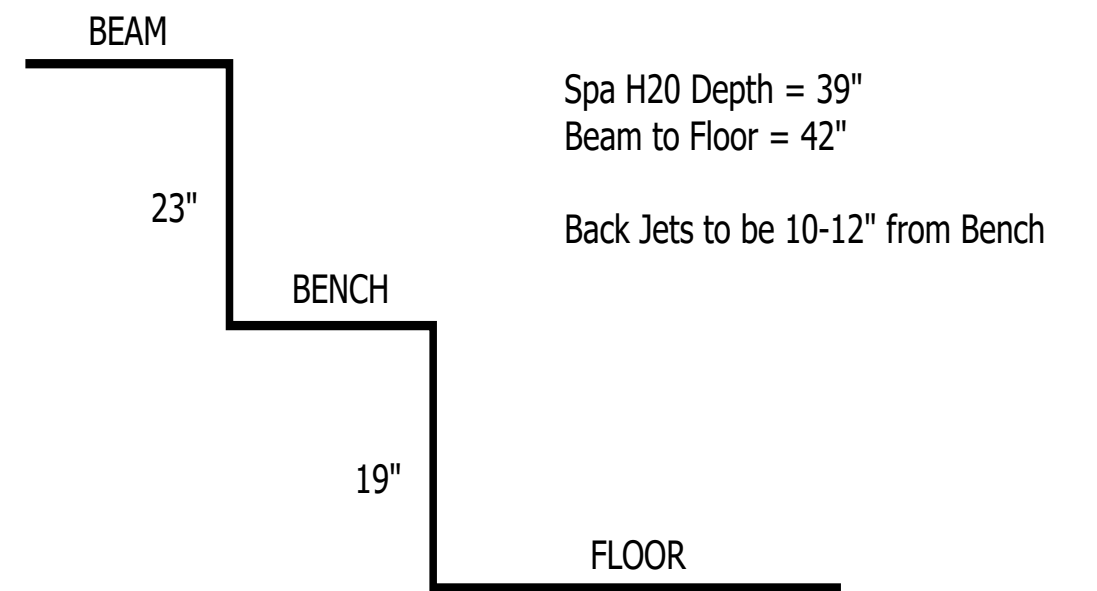

STAIR DEPTH LAYOUT

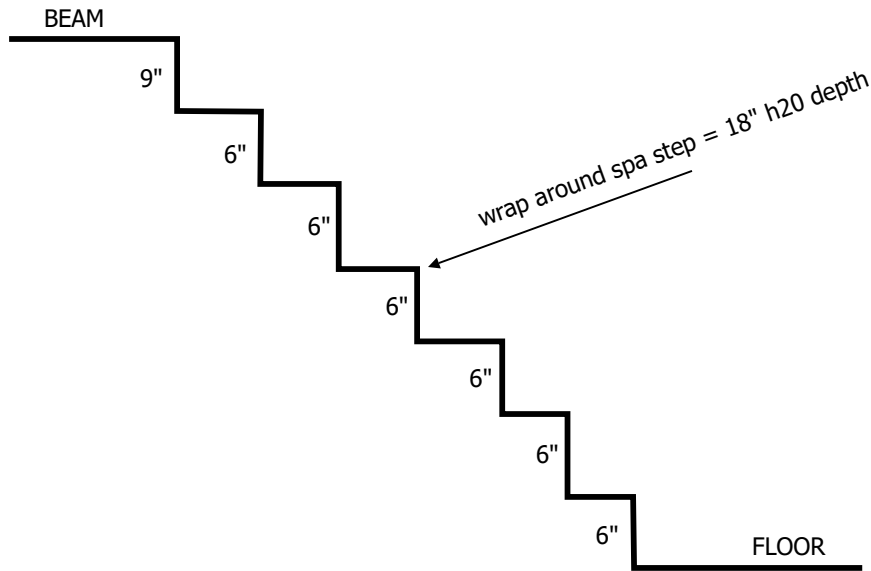

*The deeper the top step, the better (due to winter ice)
This equates to a 11" step down off coping to first step

Pool Depth = 3'6"
Thus Floor to Beam = 45"

submittal 131100-01b
Pool
 job 20-03: 217 West Shore Rd
 -
AbelowSherman
 ARCHITECTS
 -
 *PROVIDE as CORRECTED
 DATE: 09-23-22

SPA DEPTH LAYOUT

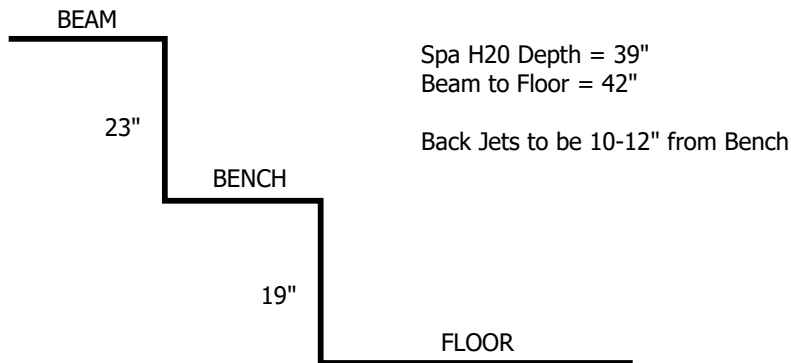

DEEP END BENCH

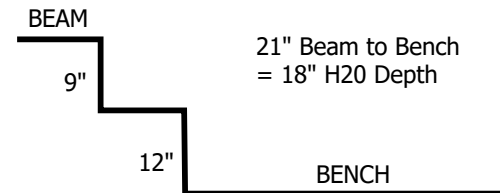

POOL & SPA LIGHT

WATERCOLORS WITH HYDROCOOL™
NICHELESS LED LIGHTS



Jandy®
Pro Series

submittal 131100-01c
Pool
job 20-03: 217 West Shore Rd
-
AbelowSherman
ARCHITECTS
-
*PROVIDE as CORRECTED

DATE: 10-10-22

submittal 131100-01b
Pool
job 20-03: 217 West Shore Rd
-
AbelowSherman
ARCHITECTS
-
*PROVIDE as CORRECTED

DATE: 09-23-22



Cool by Design

Jandy Pro Series WaterColors Nicheless LED Lights with

HYDROCOOL™
Technology

TRADE SERIES
EXCLUSIVE

POOL & SPA LIGHT

Cool by Design

The Jandy® Pro Series WaterColors Nicheless LED Lights with **NEW HydroCool™** technology feature an innovative, energy-efficient design that runs cooler and lasts longer while providing unmatched illumination.

submittal 131100-01c
Pool
job 20-03: 217 West Shore Rd

AbelowSherman
ARCHITECTS

*PROVIDE as CORRECTED

DATE: 10-10-22

New
HYDROCOOL™
Technology

RUNS COOLER AND LASTS LONGER

An innovative aluminum body, overmolded with thermally conductive plastic, transfers heat from the LEDs into the water ensuring that our lights run cooler and last longer.*

*Based on internal testing.

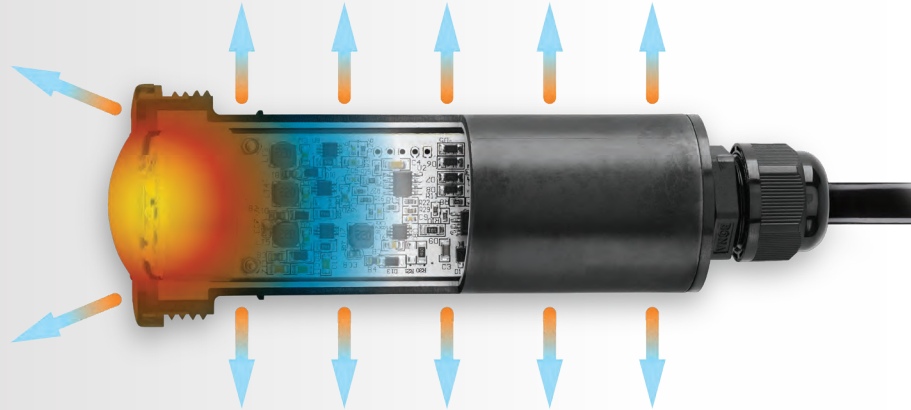

BUILT TO LAST

Triple-material, unibody construction design prevents leaks and maximizes durability under water.

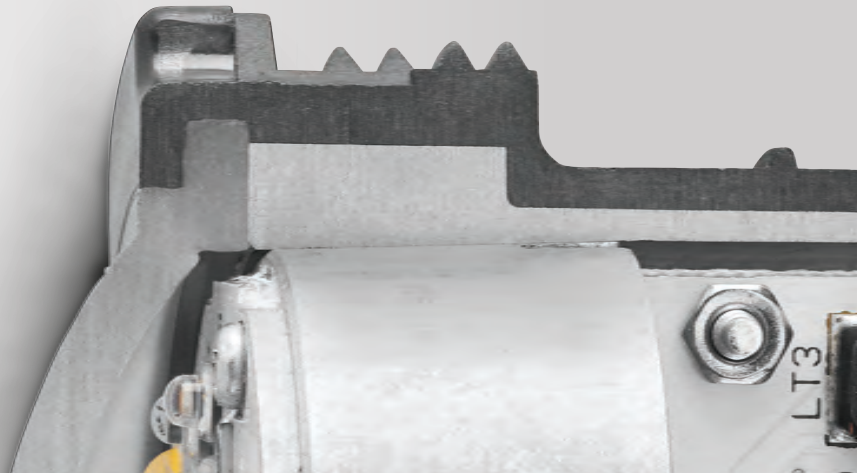

A MORE EVEN GLOW

The diffuser lens provides better blending of colors for the clearest and most consistent lighting in its class.



POOL & SPA LIGHT

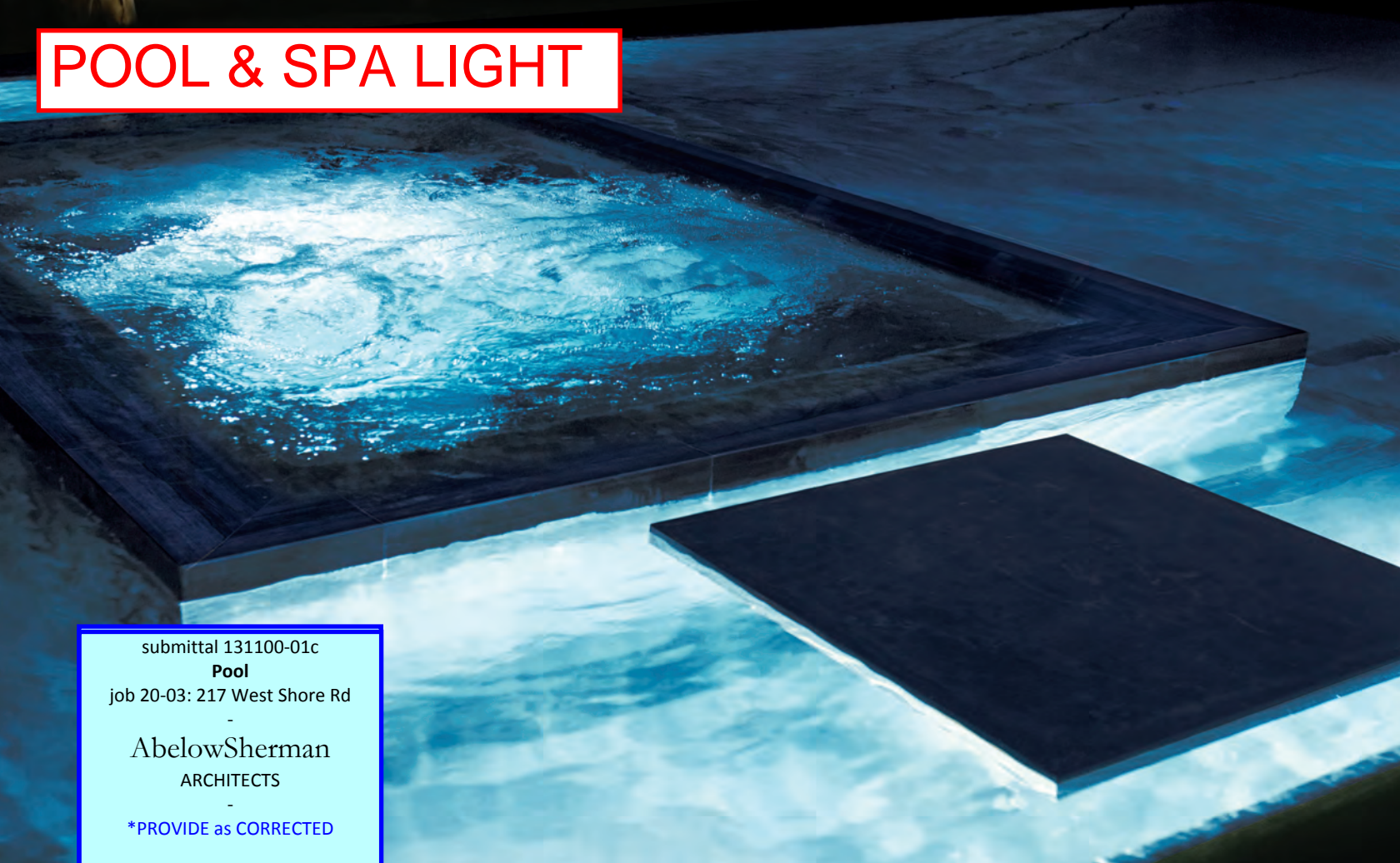

submittal 131100-01c
Pool
job 20-03: 217 West Shore Rd
-
AbelowSherman
ARCHITECTS
-
*PROVIDE as CORRECTED

DATE: 10-10-22



MADE TO MATCH

Lights come standard in black with complimentary gray and white cosmetic trim ring covers to match a larger variety of pool surfaces.

ADD HALF MOON LENS
TO ALL LIGHTS

OPTIONAL ACCESSORIES

Quarter moon and half moon lens covers eliminate reflective shadows and halos on the pool floor and help keep bright light out of swimmers' eyes in shallow areas.

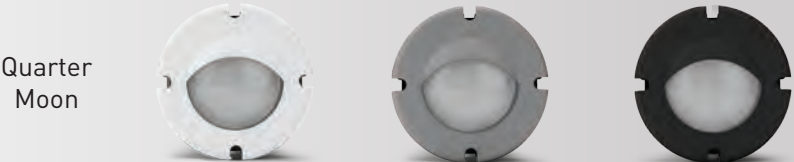
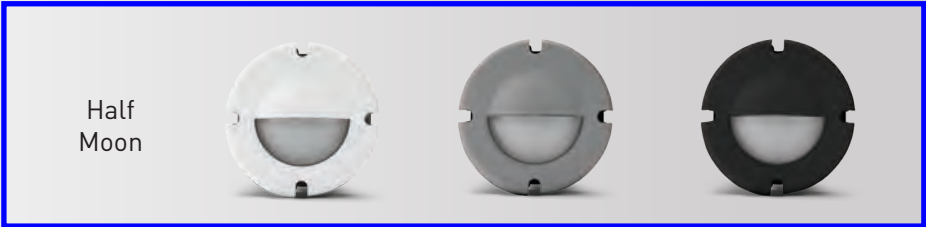

POOL & SPA LIGHT

Technical Details

INCLUDED ACCESSORIES

Every light includes a construction cover, robust installation tool and white and gray cosmetic trim rings.



Construction Cover



Installation Tool



White Cosmetic Trim Ring



Gray Cosmetic Trim Ring

SMALLER SIZE, MORE FLEXIBILITY

Up to eight inches shorter than our previous models, HydroCool™ lights are only 4½" (6W) or 5½" (12W and 24W) in length to fit even the narrowest walls for ultimate design flexibility.

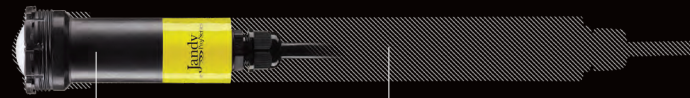
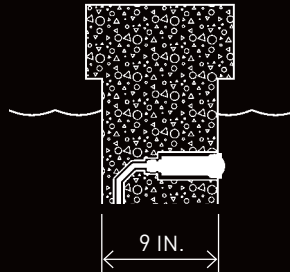

New HydroCool Light

Previous Models

MULTI-COLOR AND WHITE LIGHT OPTIONS

Color options for use with all major automation systems. In addition to Daylight White (5000K), Warm White (2700K) lights provide incandescent-like lighting and meet Dark Sky Community requirements.



Jandy® WaterColors



P-Series



H-Series



S-Series



Warm White



Daylight White

WATTAGE SELECTOR GUIDE

POOL FINISH	ILLUMINATION DISTANCE	RECOMMENDED POWER (Watts)	
		Color Lights ■ ■ ■ ■	White Lights ■ ■
Light	Up to 12 ft	6	Up to 16 ft
	12 – 20 ft	12	16 – 24 ft
	20 ft +	24	24 ft +
Medium	Up to 10 ft	6	Up to 14 ft
	10 – 16 ft	12	14 – 22 ft
	16 ft +	24	22 ft +
Dark	Up to 8 ft	6	Up to 12 ft
	8 – 12 ft	12	12 – 20 ft
	12 ft +	24	20 ft +

Visit Jandy.com for part numbers and f

USA Jandy.com | 1.800.822.7933
Canada Jandy.ca | 1.888.647.4004

©2018 Zodiac Pool Systems LLC. ZODIAC® is a registered trademark of Zodiac International, S.A.S.U., used under license. All other trademarks used herein are the property of their respective owners. 3367

submittal 131100-01c
Pool
 job 20-03: 217 West Shore Rd
 -
AbelowSherman
 ARCHITECTS
 -
***PROVIDE as CORRECTED**
 DATE: 10-10-22



POOL PUMP

PROVIDE LAYOUT SKETCH OF ALL POOL EQUIPMENT - TO BE COORDINATED WITH OTHER EQUIPMENT WITHIN THE LATEST EQUIPMENT ENCLOSURE AREA. G.C. TO CONFIRM LAYOUT OF ALL ITEMS.

DUAL VOLTAGE. IDENTICAL PERFORMANCE.

submittal 131100-01c
Pool
job 20-03: 217 West Shore Rd

AbelowSherman
ARCHITECTS

*PROVIDE as CORRECTED

DATE: 10-10-22



VS FLOPRO™
VARIABLE-SPEED PUMP

POOL PUMP

There's no need to sacrifice your pump's power.

The ideal replacement for high energy-consuming single-speed pumps up to 1.5 HP, the 115v/230v dual voltage VS FloPro™ 1.85 is *the only* variable-speed pump on the market that offers the same performance at both voltages.

• 115v/230v Dual Voltage

With the ability to provide the same head pressure and flow rates at both 115v and 230v, the VS FloPro 1.85 eliminates the need for expensive main power rewiring without compromising performance.

• Add iQPUMP01 for Instant Automation

Two auxiliary relays can be used to control other pool equipment, such as booster pumps and salt chlorinators, for easier installation and operation. No need for additional timeclocks!



• Lower Electricity Costs

Save over \$850¹ per year in energy costs! The variable-speed motor allows for dramatic energy savings and quieter operation.

• Our Quietest Variable-Speed Pump

Over 40% quieter² than other Jandy variable-speed pumps, the VS FloPro 1.85 HP features proprietary sound dampening motor technology allowing it to operate with noticeably less noise.

• Choose Your Own Controller

Designed to work with the following Jandy® control systems for complete programmability and customization (controller sold separately):

- > Jandy AquaLink® Automation Systems
- > iQPUMP01 with iAquaLink® App Control
- > JEP-R Controller

• Additional Features

- > Adjustable base for seamless direct replacement of a variety of other pumps in the aftermarket
- > Zero Clearance TEFC Motor for cool, quiet operation in tight spaces
- > 2" unions included or utilize 2" internal threads
- > Easy Controller Setup auto detects connection to an automation system or a traditional controller, eliminating the need to adjust settings manually
- > RS485 Quick Connect Port for faster installation and maintenance
- > Dry Contact Relay Control
- > Tool-free lid for easy debris removal
- > Ergonomic easy-transport handle

Jandy.com | 1.800.822.7933

©2021 Zodiac Pool Systems LLC. All rights reserved. ZODIAC® is a registered trademark of Zodiac International, S.A.S.U., used under license. All other trademarks are the property of their respective owners. 9967_SL

ADJUSTABLE BASE CONFIGURATIONS³

Base	Fits	'A' Dimension	'B' Dimension
No Base	Hayward® Super Pump® Pentair® SuperFlo® Sta-Rite® SuperMax®	7 3/4"	12 3/4"
Small Base	Hayward Super II™ Jandy PlusHP and MaxHP Pumps	8 7/8"	13 7/8"
Small Base w/ Spacers	Pentair WhisperFlo® Sta-Rite Dyna-Glas™	9 1/8"	14 1/8"
Small Base + Large Base	Sta-Rite Max-E-Pro® Sta-Rite Dura-Glas® Sta-Rite Dura-Glas II Sta-Rite Max-E-Glas®	10 3/4"	15 3/4"

DIMENSIONS

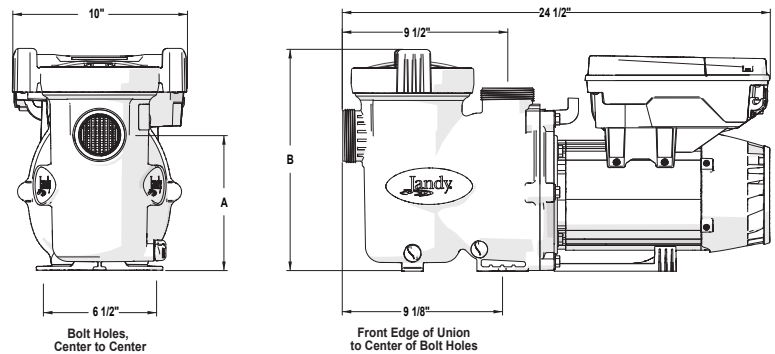

SPECIFICATIONS

Model No.	THP	WEF ⁴	Voltage	Max Watts	Amps	Union Size	Rec. Pipe Size ⁵	Carton Weight	Overall Length
VSFHP185DV2A	1.85	8.5	230 VAC 115 VAC	1,700W 1,800W	7.5 15.5	2" x 2"	1 1/2" - 2 1/2"	53 lbs.	24 1/2"

PERFORMANCE

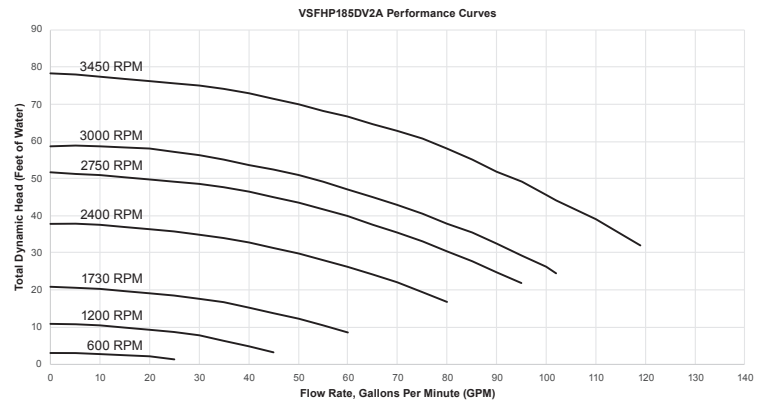

¹ Based on a 22,500 gallon pool with two turnovers per day at an energy cost of \$0.195/kWh vs. comparable single speed pumps; when tested in accordance with the applicable requirements of 10 CFR 429.

² When compared to other variable speed pumps (VSP) in the marketplace, the VS FloPro 1.85 HP variable speed pumps at 3450 RPM from 6 ft., based on their own published performance data.

³ Small base with large base is optional part R0546400.

⁴ WEF = weight efficiency factor, a performance-based metric adopted by the Department of Energy and Environmental Protection for dedicated-purpose pool pumps.

⁵ Always follow manufacturer's guidelines.

submittal 131100-01c
Pool
job 20-03: 217 West Shore Rd
-
AbelowSherman
ARCHITECTS
-
*PROVIDE as CORRECTED
DATE: 10-10-22



POOL FILTER

SFTM

Top-Mount Sand Filter



Easy to Install, Simple to Maintain



2-inch valve*



submittal 131100-01c
Pool
job 20-03: 217 West Shore Rd
-
AbelowSherman
ARCHITECTS
-
*PROVIDE as CORRECTED

DATE: 10-10-22

*2-inch valve available on SFTM24-2.0 only.

POOL FILTER

SFTM
Top-Mount Sand Filter



submittal 131100-01c
Pool
job 20-03: 217 West Shore Rd
-
AbelowSherman
ARCHITECTS
-
*PROVIDE as CORRECTED

DATE: 10-10-22

Easy to Install, Simple to Maintain

Our Top-Mount Sand Filters are designed with features to make installation easy and filter more water, faster.

» SFTM

- Large 2" valve for increased flow and enhanced filtration (SFTM24-2.0)
- 7-position multi-port valve can be rotated to quickly adjust filter mode
- 360° clamp-style valve rotates for easy installation
- Laterals fold up/down for quick installation and to service (SFTM24-2.0)
- Blow-molded tank is corrosion- and UV-resistant
- Combination water/sand drain for easy maintenance
- Unions and adapters included— no need to buy additional parts



7-position multi-port valve for 2" plumbing (SFTM24-2.0)



SFTM24-2.0

SFTM22-1.5

Folding laterals for quick installation and serviceability*



* SFTM24-2.0

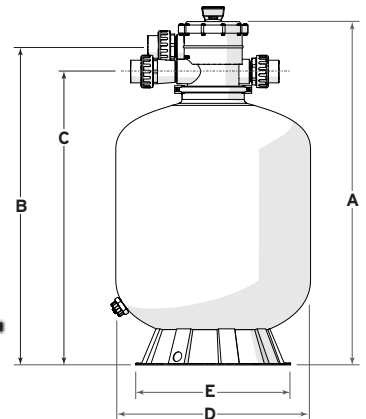

DIMENSIONS

	SFTM22-1.5	SFTM24-2.0
Height - Dimension "A"	31"	41.85"
Inlet Port - Dimension "B"	33.4"	38.75"
Outlet Port - Dimension "C"	28.6"	35.75"
Tank Width - Dimension "D"	22"	23.75"
Base Width - Dimension "E"	19"	19"

SPECIFICATIONS

	SFTM22-1.5	SFTM24-2.0
Filtration Area	2.60 ft ²	3.04 ft ²
Valve Plumbing Size	1½"	2"
Filtration Flow Rate	50 gpm	60 gpm
Backwash Flow Rate	38 gpm	40 gpm
Max Working Pressure	35 psi	35 psi
Eight (8) Hour Turnover Rate	24,960 gallons	29,760 gallons
Ten (10) Hour Turnover Rate	31,200 gallons	37,200 gallons
Sand Required	250 lbs.	300 lbs.
Sand Requirements	#20 Silica Sand 40-55mm	#20 Silica Sand 40-55mm

Zodiac Pool Systems, Inc.
2620 Commerce Way, Vista, CA 92081
1.800.822.7933 | www.zodiac.com

Zodiac Pool Systems Canada, Inc.
2115 South Service Road West, Unit #3, Oakville, ON L6L 5W2
1.300.763.021 | www.ZodiacPoolSystems.ca

ZODIAC® FAMILY OF BRANDS | Heritage of Excellence

©2017 Zodiac Pool Systems, Inc. ZODIAC® is a registered trademark of Zodiac International, S.A.S.U., used under license. All other trademarks used herein are the property of their respective owners. SL6975 Rev A 0417



POOL HEATER

**HEAT WHEN YOU WANT.
SAVE WHEN YOU DON'T.**



submittal 131100-01c
Pool
job 20-03: 217 West Shore Rd
-
AbelowSherman
ARCHITECTS
-
*PROVIDE as CORRECTED

DATE: 10-10-22



JXi™
POOL & SPA HEATER
with VERSAFLO™

POOL HEATER

Save even more with VersaFlo™ Integrated Bypass

Here's How:

- The heater is typically only used 3.5% of average annual pump runtime, the other 96.5% of the time the heat exchanger can be bypassed.
- JXi™ with VersaFlo activates the built-in flow bypass valve based on call for heat to avoid running water through the heat exchanger when water does not need to be heated.
- Variable-speed pumps can be run at lower speeds, requiring considerably less electricity, thereby providing for significantly reduced electricity costs.
- VersaFlo Integrated Bypass is available on select models or can easily be added to any JXi heater in the field.

5-Year Heat Exchanger Warranty

JXi heaters with VersaFlo factory installed receive an industry leading 5-Year standard warranty on the heat exchanger.

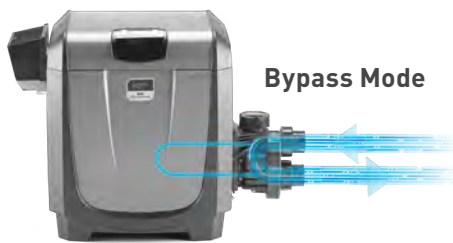

Bypass Mode



Heat Mode

Available in the Following Models

Model #	Model # with VersaFlo	Firing Rate	Gas Type	Heat Exchanger	Thermal Efficiency	Dim A	Weight	Vent Diameter*	Minimum GPM	Maximum GPM
JXi200N	JXi200NK	200K BTU	Natural Gas	Copper	83%	34.5	117 lbs.	6" (15 cm)	30	100
JXi260N	JXi260NK	260K BTU	Natural Gas	Copper	84%	34.5	120 lbs.	7" (18 cm)	30	100
JXi400N	JXi400NK	399K BTU	Natural Gas	Copper	84%	34.5	126 lbs.	8" (20 cm)	30	100
JXi400NN		399K BTU	Natural Gas	Cupronickel	83%	34.5	126 lbs.	8" (20 cm)	30	100
JXi200P	JXi200PK	200K BTU	Propane	Copper	83%	34.5	117 lbs.	6" (15 cm)	30	100
JXi260P	JXi260PK	260K BTU	Propane	Copper	84%	34.5	120 lbs.	7" (18 cm)	30	100
JXi400P	JXi400PK	399K BTU	Propane	Copper	84%	34.5	126 lbs.	8" (20 cm)	30	100
JXi400PN		399K BTU	Propane	Cupronickel	83%	34.5	126 lbs.	8" (20 cm)	30	100
JXiVFKIT	JXi VersaFlo Accessory Kit (Not compatible with ASME certified heaters)									



ASME Certified JXi Heaters (Not available with VersaFlo Integrated Bypass technology)

* Minimum vent pipe size for Category I installations.

** Savings based on testing a 28,000 gallon pool with 2 turnovers per day at an average power of 0.21 \$/kWhr; using a Jandy ePump, Jandy CV Filter and JXi Heater without VersaFlo, compared to the same system setup with a JXi Heater with VersaFlo. Tested in accordance with the applicable requirements of Department of Energy 10 CFR 429 and 431.

*** Pool pump and filter run time based on calculated average of nationwide survey of pool owners.

† Uses the average cost of electricity for residential service for Los Angeles Metro Area between August 2015 and August 2016. Source: www.bls.gov

Stop wasting electricity and money pushing water through your pool heater when you don't need to!

submittal 131100-01c Pool job 20-03: 217 West Shore Rd - AbelowSherman ARCHITECTS - *PROVIDE as CORRECTED DATE: 10-10-22	Heater without VersaFlo	Heater with VersaFlo
	3,000 Hours	100 Hours
	0 Hours	2,900 Hours
	Heater without VersaFlo	Heater with VersaFlo
Heater**	3300 KW	110 KW
Heater**	0 KW	1537 KW
Electricity Cost†	0.21 \$/KWhr	0.21 \$/KWhr
Total Cost to Operate Pump**	\$695	\$345

Annual energy savings of up to \$350** with VersaFlo

Jandy.com | 1.800.822.7933

©2020 Zodiac Pool Systems LLC. All rights reserved. ZODIAC® is a registered trademark of Zodiac International, S.A.S.U., used under license. All other trademarks are the property of their respective owners. 5872_SL

AQUALINK® RS
POOL CONTROL USER INTERFACES



Jandy®
Pro Series

POOL AUTOMATION



Automate and control your backyard experience with the most user-friendly, innovative pool control systems.

submittal 131100-01c
Pool
job 20-03: 217 West Shore Rd

AbelowSherman
ARCHITECTS

*PROVIDE as CORRECTED

DATE: 10-10-22

COMPLETE CONTROL

POOL AUTOMATION

AquaLink® RS

ADVANCED AUTOMATION TECHNOLOGY

These interfaces are the perfect companion to Zodiac's top-of-the-line Jandy® AquaLink RS systems, and enable total control of your backyard experience. Adjust pool and spa temperatures, turn on water features and lights, adjust sanitizer generation, and much more, with the touch of a button. AquaLink RS systems integrate premium design ingenuity, style, and ease of use for the ultimate pool/spa automation experience.

AQUALINK RS SYSTEMS ALLOW YOU TO:

- Control individual pool and spa equipment from the convenience of your home
- Automate daily pool equipment functions, such as filtration, sanitation and cleaning
- Protect your equipment from damage due to freezing
- Manage up to 32 pool and spa features
- Integrate pool and spa automation into most leading home automation systems

ENERGY SMART PROGRAM

AquaLink RS systems have built-in energy savings programs, allowing the system to automatically adjust routines and schedules with the changing seasons to optimize energy savings and maximize efficiency.

JANDY AQUALINK RS ONE TOUCH™



- One Touch features macros for an easy “set-it and forget-it” experience
- Customize your entire system to bring your backyard to life
- The small panel, which is the size of a double light switch, can be flush or surface-mounted to fit with any room décor. Additional bezel colors available

JANDY AQUALINK RS ALL BUTTON



- Brings the convenience of pool and spa control into your home
- Simple to operate, attractively styled, and easily installs indoors
- Custom labeled buttons to match your system and backyard environment

AQUALINK WIRELESS HANDHELD REMOTE CONTROL



- Complete system control with a wireless, handheld remote
- Uses inexpensive, long-lasting, AA batteries. No charger needed
- Tough, water-resistant, soft-grip housing. Perfect for worry-free control in or around the pool or spa
- Back-lit display for easy reading - even at night

AQUALINK RS SPA SIDE CONTROLLERS



- Convenient spa-side controls for system control from inside the spa

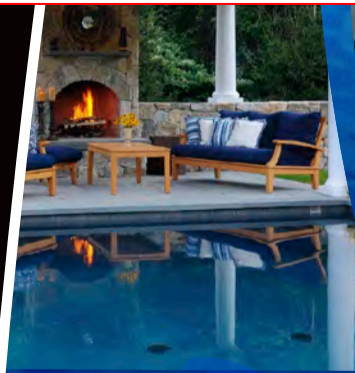

submittal 131100-01c
Pool
job 20-03: 217 West Shore Rd
-
AbelowSherman
ARCHITECTS
-
*PROVIDE as CORRECTED
DATE: 10-10-22



POOL AUTOMATION

iAquaLink™

**SMART DEVICE.
SMART POOL.
SMART YOU.**

INTELLIGENT POOL CONTROL FROM YOUR SMART PHONE, TABLET OR WEB-CONNECTED DEVICE

iAquaLink allows you to control your pool anytime, anywhere. Using our free apps for your smart phone, tablet, or web-connected device, you can control all the elements of your pool or pool/spa system, even when you're on the go.

IAQUALINK IS EASY & CONVENIENT

On the golf course or on the go, control your pool anytime, anywhere with iAquaLink.

- Most intuitive and user-friendly mobile pool controller ever
- iAquaLink can be used alone, or combined with the complete line of wall-mounted or wireless AquaLink® RS interfaces (Shown on opposite page)
- User accounts can be created in minutes, used immediately, and the service is free
- Control multiple pools from a single user account

POWERFUL & VERSATILE

- Upgrades available for virtually any AquaLink, Jandy® or Zodiac® controller ever made
- No unsightly wires, wall panels, or charging bases required
- Compatible with most residential WiFi and Ethernet networks
- Easy, hassle-free online registration
- Professional installation required

BROAD PLATFORM SUPPORT: NO POOL CONTROL SYSTEM OFFERS GREATER COMPATIBILITY WITH MORE MOBILE PLATFORMS THAN IAQUALINK.

- Free apps for Apple® and Android® smartphones and tablets
- Mobile web app delivers a true mobile-optimized app experience to virtually any smart device with an HTML5 capable web browser.



submittal 131100-01c
Pool
job 20-03: 217 West Shore Rd
-
AbelowSherman
ARCHITECTS
-
***PROVIDE as CORRECTED**

DATE: 10-10-22

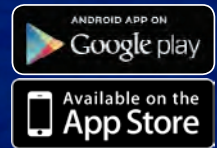
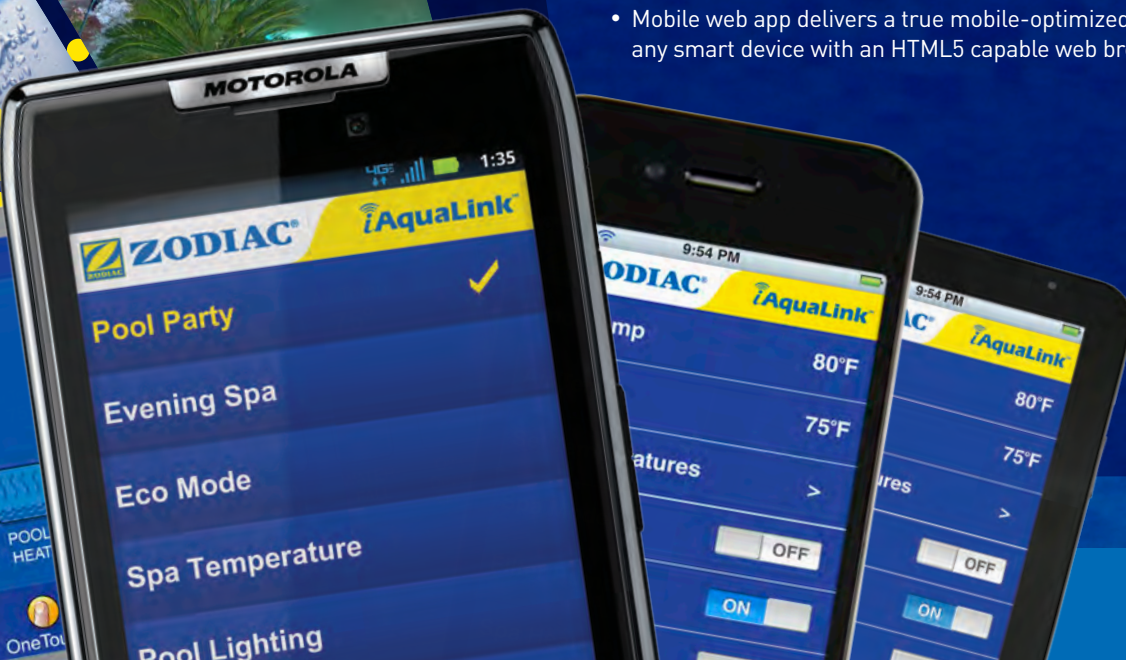

submittal 131100-01c
Pool
job 20-03: 217 West Shore Rd
-
AbelowSherman
ARCHITECTS
-
***PROVIDE as CORRECTED**

DATE: 10-10-22

POOL AUTOMATION

RELAX...

And enjoy an easy way of life with AquaLink® RS Controls



iAQUALINK™ & AQUALINK RS COMPLETE CONTROL

Monitor and adjust all equipment controlled by the AquaLink system.

- Pool Temperature
- Spa Temperature
- Waterfalls
- Spillovers
- Laminar Jets
- Light Dimmers
- Pool Cleaner
- LED Color & White Lights
- Landscape Lights
- Filter Pump
- Booster Pump
- Irrigation & Sprinkler Systems
- Fountains
- Dehumifiers & Chillers
- And Much More

OPTIONS

- PureLink™ salt-water sanitizer integration
- Chemical automation to automate pH balance and sanitizer levels
- Home automation interface to seamlessly integrate with most home automation systems

Zodiac Pool Systems, Inc.
2620 Commerce Way, Vista, CA 92081
1.800.822.7933 | www.ZodiacPoolSystems.com

Zodiac Pool Systems Canada, Inc.
2115 South Service Road West, Unit #3, Oakville, ON L6L 5W2
1.888.647.4004 | www.ZodiacPoolSystems.ca

 ETL LISTED
CONFORMS TO
UL STD 1563
Intertek
CERTIFIED TO
CAN/CSA C22.2 NO. 218.1

 *Not all models
are available
with CE certification

POOL AUTOMATION



How to use the product icons **RPT**

Step 1

Select a system board. Its icon will be used to select other components.

Step 2

Select interface(s) compatible with the system board.

Step 3

Choose the power center. If a PureLink™ power center is selected, which integrates salt chlorinator control, proceed to Step 4.

Automation Selection Guide

Customize automation solutions for any application. The AquaLink® family of modular components work together to provide reliable, easy to use, and easy to set up pool and spa automation.

Features	Pool & Spa Automation	Variable-Speed Pump Control	Freeze Protection	Chlor Light Control	Solar Heat Control	AquaLink® Control	In AquaLink® Setup	AquaLink® Scheduling	Wireless Interface Included	One-Touch™ Macros / Hotkeys	Function AquaLink® Remote	Smart Control Capable	Seasonal Auto-Adjust (Energy Savings Plan)	Temperature Priority Logic	Automatic Disk Control	Integrates with Home Automation
R AquaLink RS	✓	✓	✓	✓	✓	○	○	○	○	6	○	✓	✓	✓	✓	○
P AquaLink PDA	✓	✓	✓	✓	✓	○	×	×	✓	2	×	×	×	×	×	×
T AquaLink TCX	✓*	✓	✓	✓	✓	✓	✓	✓	×	×	✓	×	✓	×	×	×

*AquaLink TCX is for pool automation only (no spa).

KEY ✓ Included | ○ Optional | × Not Available

1 Select the System Board



R AquaLink RS

Pool & Spa Combo
Dual Body – Shared Equipment

	Part Number	Power Centers Required*	Power Centers	System Board	Total 3HP Relays	JVAs Included/Max
Pump, Heater, & 3 Aux	RS-PS4	1*	4	0	4	2/4
Pump, Heater, & 5 Aux	RS-PS6	1*	4	2	6	2/4
Pump, Heater, & 7 Aux	RS-PS8	1*	4	4	8	2/4
Pump, Heater, & 11 Aux	RS-PS12	2*	8	4	12	2/8
Pump, Heater, & 15 Aux	RS-PS16	2*	8	8	16	2/8
Pump, Heater, & 23 Aux	RS-PS24	3*	12	12	24	2/12
Pump, Heater, & 31 Aux	RS-PS32	4*	16	16	32	2/16
Pool Only / Spa Only Single Body Only						
Pump, Heater, & 3 Aux	RS-P4	1*	4	0	4	0/4
Pump, Heater, & 5 Aux	RS-P6	1*	4	2	6	0/4
Pump, Heater, & 7 Aux	RS-P8	1*	4	4	8	0/4
Pump, Heater, & 15 Aux	RS-P16	2*	8	8	16	0/8
Pool & Spa Dual Dual Body – Dual Equipment						
2 Pumps, 2 Heaters, & 6 Aux	RS2-6	1*	4	4	8	0/4
2 Pumps, 2 Heaters, & 10 Aux	RS2-10	2*	8	4	12	0/8
2 Pumps, 2 Heaters, & 14 Aux	RS2-14	2*	8	8	16	0/8
2 Pumps, 2 Heaters, & 22 Aux	RS2-22	3*	12	12	24	0/12
2 Pumps, 2 Heaters, & 30 Aux	RS2-30	4*	16	16	32	0/16

P AquaLink PDA



Pool & Spa Combo
Dual Body – Shared Equipment

Pool Only / Spa Only
Single Body Only

submittal 131100-01c
Pool
job 20-03: 217 West Shore Rd
-
Abelow Sherman
ARCHITECTS
-
***PROVIDE as CORRECTED**

DATE: 10-10-22

Part Number	Power Centers Required*	Power Centers	System Board	Total 3HP Relays	JVAs Included/Max
PDA-PS4	1*	4	0	4	2/4
PDA-PS6	1*	4	2	6	2/4
PDA-PS8	1*	4	4	8	2/4
PDA-P4	1*	4	0	4	0/4
PDA-P8	1*	4	4	8	0/4

T AquaLink TCX



Pool Only
Single Body Only

Part Number	Power Center	Power Interface Module	System Board	Total 3HP Relays	JVAs Included/Max
VS Pump, Heater, & 1 Aux	TCXP	Included	1	1	0/1
Single-Speed Pump, Heater, & 0 Aux	TCXP	Included	1	1	0/1
VS Pump, Heater, & 1 Aux	TCXP CONV	Optional	1	1	0/1
Single-Speed Pump, Heater, & 0 Aux	TCXP CONV	Optional	1	1	0/1



*Assumes up to eight 3HP relays per power center. The 6612F power center cannot hold more than four 3HP relays.



POOL AUTOMATION

G.C. TO INSTALL AQUALINK RS ONETOUCH AT CABANA b115, ABOVE LIGHT SWITCH ON EAST WALL (SOUTH OF SLIDING DOOR). LOCATION MARKED IN THE FIELD WITH G.C.

2 Select the Interfaces Lettered dots indicate system compatibility.

AquaLink® Interfaces

Device	Description	Part Number
iQ30 Web-Connect Device* R P	 Web-Connect Device	iQ30-A May be included in some bundled kits (i.e., iQ904-PS, iQ904-P, ZQ-4PSi, & ZQ-4Pi). Smartphone not included with iAquaLink®.
AquaLink RS** OneTouch™ R	 OneTouch, White ← OneTouch, Black	7953 7954
AquaLink RS** All-Button R	 4-Function (P&S) 6-Function (P&S) 8-Function (P&S)	6890 6888 6886

Device	Description	Part Number
AquaLink Wireless Handheld Remote R P	 Wireless Handheld Remote & Transceiver (18-Channel) Use to control RS & Z4 systems. Use to program PDA systems. Included with PDA systems.	AQWHR18
SpaLink®** 8-Function Spa Side Remote R	 Black 150" w/ Frame Flush-Mount Mud Box	7888 7940
Spa Side** 4-Function Spa Side Remote R P	 White 150" Gray 150" ← Black 150"	7443 8050 7444

*Required for iAquaLink App Integration

**See Automation Accessories section of catalog for other available configurations.

3 Select the Power Center



AquaLink & PureLink™ Power Centers

Power Center	3HP Relays (Included/Max)	Sub-Panel	Number of Breakers (Max)	Salt Chlorinator Control	Part Number
R P PureLink Sub-Panel Power Center for Automation and Saltwater Chlorination	4/8	✓	12	✓***	6614AP-L
R P PureLink Power Center for Automation and Saltwater Chlorination	4/8	No	0	✓***	6613AP
R P AquaLink Sub-Panel Power Center for Automation Control Systems	4/8	✓	12	No	6614-LD
R P AquaLink Power Center for Automation Control Systems	4/8	No	0	No	6613
R P Compact Power Center for Basic Automation Control Systems	4/4	No	0	No	6612F
R P AquaPure® Power Pack. Used to power & control AquaPure & Fusion Soft salt chlorinators. Not an enclosure for Automation systems.	0/0	No	0	✓***	APUREM FUSIONM

NOTE: FSOFT700 & FSOFT1400 are NSF® approved only when used with FUSIONM.

***Requires purchase of a salt chlorinator. Proceed to Step 4 (below)

4 Choose a Salt Chlorinator



Saltwater Chlorination

Device
R P T AquaPure® 3-Port Salt Chlorinator Cell
R P T Fusion Soft — Salt Chlorinator system with integrated Nature ² ® Mineral Sanitizer technology
R P T TruClear® Salt Chlorinator

submittal 131100-01c
Pool
job 20-03: 217 West Shore Rd

AbelowSherman
ARCHITECTS

*PROVIDE as CORRECTED

DATE: 10-10-22

or pools up to	Part Number
12K Gallons	PLC700
40K Gallons	PLC1400
12K Gallons	FSOFT700
40K Gallons	FSOFT1400
35K Gallons	TRUCLEAR11K
35K Gallons	TRUCLEAR11KU

Jandy.com | 1.800.822.7933

©2022 Zodiac Pool Systems LLC. All rights reserved. ZODIAC® is a registered trademark of Zodiac International, S.A.S.U., used under license. All other trademarks are the property of their respective owners. 9544_SL

For live help selecting the right automation system, please call Fluidra® technical support M – F 6AM – 5PM (PST), 9AM – 8PM (EST) at 1.800.822.7933, or email us any time at: productsupport@fluidra.com



POOL SALT WATER SYSTEM

submittal 131100-01c
Pool
job 20-03: 217 West Shore Rd
-
AbelowSherman
ARCHITECTS
-
*PROVIDE as CORRECTED

DATE: 10-10-22

Create a Saltwater Oasis



POOL SALT WATER SYSTEM

AQUAPURE

Water Purification System

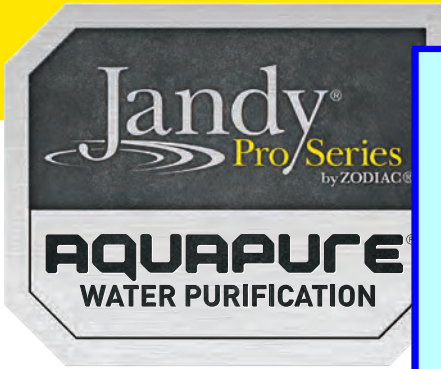

submittal 131100-01c
Pool
 job 20-03: 217 West Shore Rd
 -
Abelow Sherman
 ARCHITECTS
 -
 *PROVIDE as CORRECTED
 DATE: 10-10-22

THE HEAVY-DUTY STANDARD FOR MAXIMUM PERFORMANCE

AquaPure salt-water chlorine sanitizing systems use salt-water to deliver high-performance water sanitation with uncompromised performance, reliability, and hydraulic efficiency.

» Robust Features

- Automatic self-cleaning feature, which ensures consistent operation and extends the life of the cell.
- Professional-grade, ruthenium coated titanium electrodes for long-term reliability.
- Exclusive Tri-Sensor technology — reliable electronic water flow detection to ensure maximum performance, even at very low flow rates (to take advantage of the benefits of VS pumps).
- Digital salinity read-out for accurate salt level indication
- Flow, temperature, and status readings provide instant feedback on the current operation.

» Easy Integration

- Seamless communication with AquaLink® Control systems, enabling easy monitoring of salt levels and convenient, precise sanitizer output settings.
- When combined with PureLink™ power centers, AquaLink and AquaPure work together for the ultimate in pool sanitizing and remote operation convenience.

Zodiac Pool Systems, Inc.
 2620 Commerce Way, Vista, CA 92081
 1.800.822.7933 | www.ZodiacPoolSystems.com

Zodiac Pool Systems Canada, Inc.
 2115 South Service Road West, Unit #3, Oakville, ON L6L 5W2
 1.888.647.4004 | www.ZodiacPoolSystems.ca

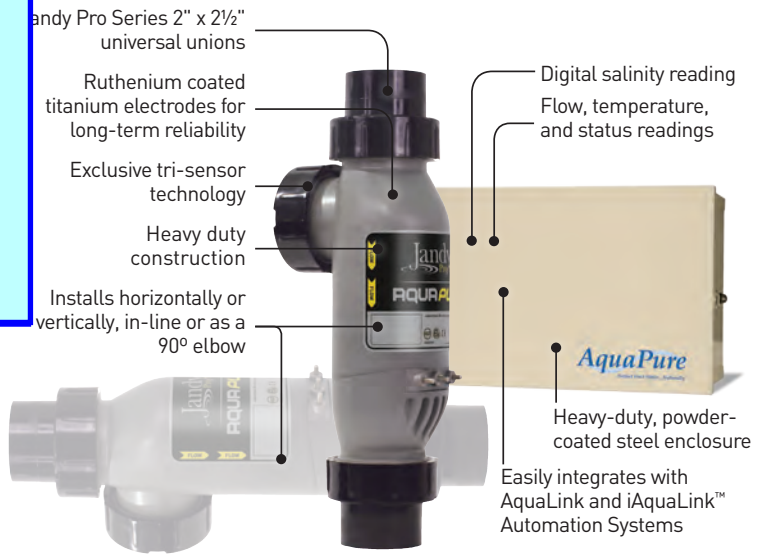

SPECIFICATIONS

Model	PLC700	PLC1400
Pool Size*	Up to 12,000 Gallons	Up to 40,000 Gallons
Input	120 VAC, 50/60 Hz, 1.5 AMPS 240 VAC, 50/60 Hz, 0.75 AMPS	120 VAC, 50/60 Hz, 2.5 AMPS 240 VAC, 50/60 Hz, 1.25 AMPS
Output	22-30 VDC @ 3 AMPS maximum	22-30 VDC @ 6 AMPS maximum
Chlorine	0.625 lb./24 Hr. (283 gm/24 Hr.)	1.25 lb./24 Hr. (567 gm/24 Hr.)
Recommended Flow Rate	20-120 GPM	20-120 GPM

*Pool sizes are generalizations and may vary with environmental conditions. Pools with greater exposure to sunlight may require greater chlorine production capacity.

HEAD LOSS CHART

Exceptional Hydraulic Efficiency

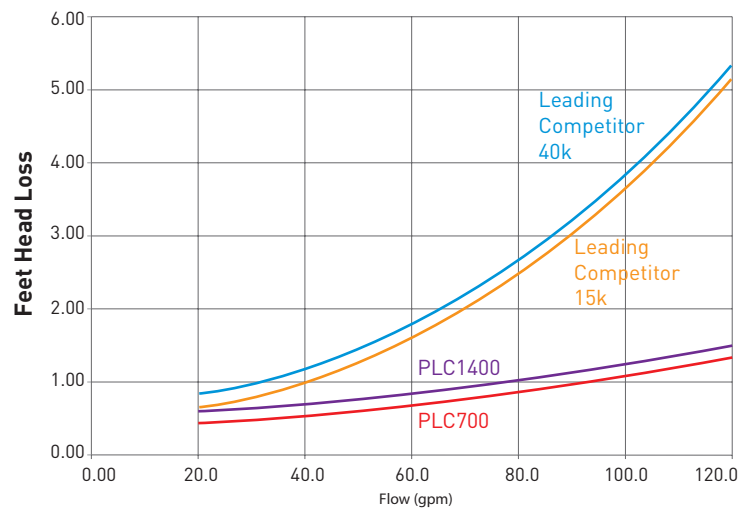

Lower head loss = more efficient



©2014 Zodiac Pool Systems, Inc. SL6605 Rev B 0414
 ZODIAC® is a registered trademark of Zodiac International, S.A.S.U., used under license.
 All other trademarks used herein are the property of their respective owners.





POOL ACID SYSTEM



SIMPLE, CONVENIENT CHEMICAL DOSING

submittal 131100-01c
Pool
job 20-03: 217 West Shore Rd
-
AbelowSherman
ARCHITECTS
-
*PROVIDE as CORRECTED

DATE: 10-10-22



POOL ACID SYSTEM

Jandy® TruDose™ properly maintains your pool chemical levels

Keep your pool water continually balanced with the Jandy TruDose chemical controller. Engineered to maintain consistent water chemistry, it monitors pH and chlorine activity (ORP) and adds chemicals as needed.

- **Automatic Chemical Dosing**
Detects pH and ORP readings and doses appropriately as needed to maintain balanced water chemistry between service visits
- **Perfect Partner for Jandy Salt Systems**
Works with the Jandy AquaPure® salt chlorinator to power chlorination on and off
- **Protects Your Pool**
Protects pool equipment and surfaces from corrosion and scaling by eliminating 'peaks and valleys' of inconsistent water chemistry

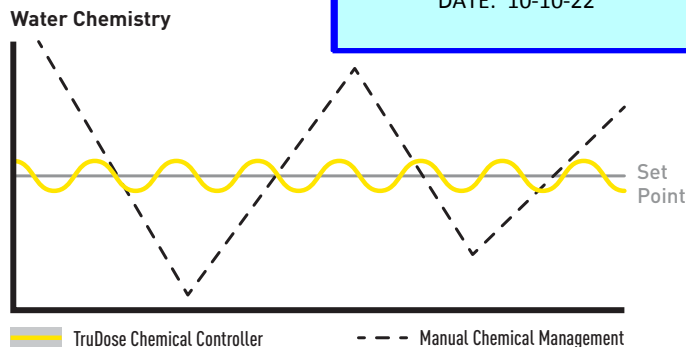

submittal 131100-01c
Pool
job 20-03: 217 West Shore Rd
-
AbelowSherman
ARCHITECTS
-

*PROVIDE as CORRECTED

DATE: 10-10-22



- **Eliminates Wasted Chemicals**
TruDose uses only as much or as little is needed
- **Auto-Adjusts for the Season**
TruDose maintains pH and chlorine levels based on actual demand
- **Safer for Swimming**
Over-feeding alerts prevent overdosing the pool with acid or chlorine
- **A More Enjoyable Experience**
Properly maintained chemical levels help safeguard against waterborne illnesses and overexposure to unnecessary chemicals
- **Easy to Program**
Intuitive interface makes it simple to program pH and ORP setpoints
- **Easy Installation**
TruDose comes pre-mounted and plugs into a GFCI outlet so there's no need for hardwiring

PRO SPECS

- Controller has an integrated peristaltic pump for dispensing liquid acid
- 22 GPD pump doses enough acid for most residential pools
- 24VAC connection from the TruDose chemical controller to the saltwater chlorine generator power pack
- Easy electrical connection plugs into a GFCI-protected wall outlet
- Acid chemical tank sourced separately
- Fittings and tap included for installing tubing connections to plumbing
- Spare parts available for replacing the sensors and maintaining the peristaltic pump
- Pre-mounted on 18" x 10" board for easy installation
- Standalone unit, does not require connection to automation

Jandy.com | 1.800.822.7933



**Jandy TruDose
Chemical Controller**

Jandy® TruDose™ Chemical Controller

- Automatic Chemical Dosing – Detects pH and ORP readings and doses as needed to maintain balanced water chemistry between service visits
- Perfect Partner For Jandy Salt Systems – TruDose controls saltwater chlorination in conjunction with Jandy® AquaPure® salt chlorinator
- Protects Your Pool – Protects pool equipment and surfaces from corrosion and scaling by eliminating ‘peaks and valleys’ of inconsistent water chemistry
- Eliminates Wasted Chemicals – TruDose uses only as much or as little is needed
- Auto-Adjusts for the Season – TruDose maintains pH and chlorine levels based on actual demand
- Safer for Swimming – Over-feeding alerts prevent overdosing the pool with acid or chlorine
- A More Enjoyable Experience – Properly maintained chemical levels safeguard against waterborne illnesses and overexposure to unnecessary chemicals
- Easy to Program – LED screen and intuitive interface make it simple to program pH and ORP setpoints
- Easy Installation – TruDose comes pre-wired and plugs into a GFCI outlet so there’s no need for hardwiring

Part No.	Description
TRUDOSE	TruDose Chemical Controller Bundle

submittal 131100-01c
Pool
 job 20-03: 217 West Shore Rd
 -
AbelowSherman
 ARCHITECTS
 -
 *PROVIDE as CORRECTED
 DATE: 10-10-22

Jandy® TruDose™ Chemical Controller

Part No. TRUDOSE

Key No.	Part No.	Description
1	R0944400	Controller Only
2	R0894300	pH Sensor
	R0894400	ORP Sensor
3	R0944900	Flow Cell w/ Flow Switch, VLV, FTGS
4	R0945000	Inline Filter w/ Screen & FTGS
5	R0962000	Compression Fitting Kit
6	R0944600	3/8" Black Poly Tubing (25 Foot Roll)
7	R0944500	1/4" Black Poly Tubing (20 Foot Roll)
8	R0945300	Pump Accessory Kit
9	R0944300	Power Supply
10	R0945100	Flow Switch
11	R0945200	Squeeze Tubes (2 Pack)
12	R0945400	Peristaltic Acid Pump
13	R0961700	Pump Roller Assembly
14	R0962100	SWC Cable 24VDC
15	R0944100	PCBA Replacement

submittal 131100-01c
Pool
 job 20-03: 217 West Shore Rd
 -
AbelowSherman
 ARCHITECTS
 -
 *PROVIDE as CORRECTED
 DATE: 10-10-22

Jandy® TruDose™ Chemical Controller

Part No. TRUDOSE

POOL ACID SYSTEM

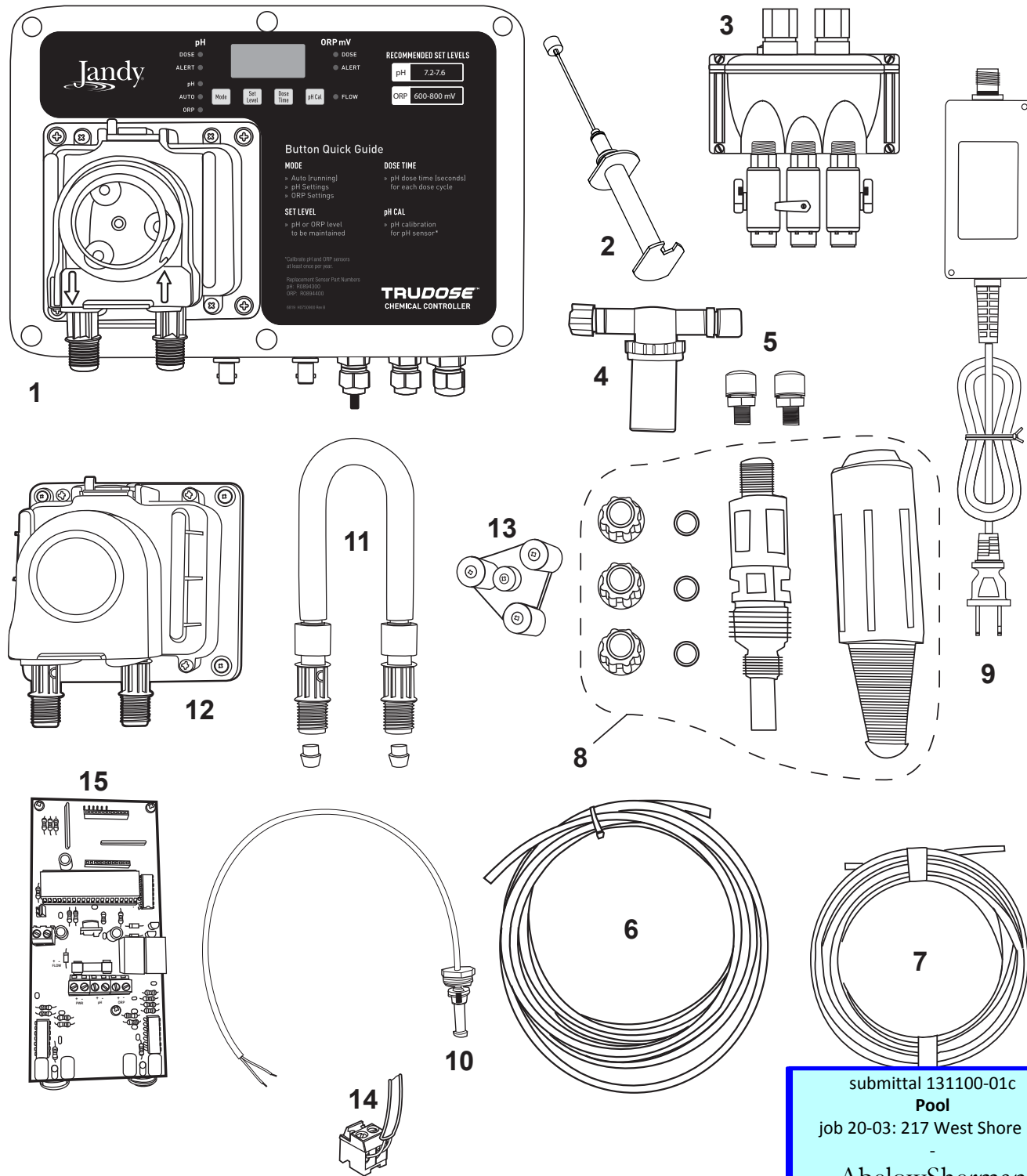

submittal 131100-01c
Pool
 job 20-03: 217 West Shore Rd
 -
AbelowSherman
 ARCHITECTS
 -
 *PROVIDE as CORRECTED
 DATE: 10-10-22